



Ref. 036ARTEK70

Artek 70 VISION: A característica que o diferencia do Artek 70 é unicamente o seu **vidro serigrafado**, vidro este que lhe confere um visual mais arrojado.

Artek 70 VISION: The distinguishing feature of Artek 70 is its **screen-printed glass**, which gives it a bolder look.

Obs. O vidro serigrafado mantém-se sempre frio ao toque, não emitindo calor.
Note: Screen-printed glass always stays cool to the touch and does not emit heat.







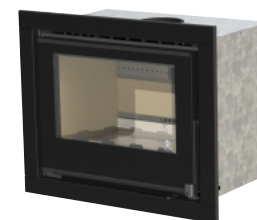



CARACTERÍSTICAS | CHARACTERISTICS

- Saída de Fumos: Superior; Smoke output: Superior;
- Duas saídas de distribuição de calor Ø 120 mm; Two heat exchanger outputs;
- Recuperador de calor com dimensões standard para a maioria das lareiras construídas; With standard dimensions, this appliance fits in most of the fireplaces built;
- Fácil instalação, utilização, acendimento e manutenção; Easy installation, use, ignition and maintenance;
- Câmara de queima com base THERMCORIT®; Burning chamber THERMCORIT®;
- Laterais e sifão em vermiculite; Sides and siphon in vermiculite;
- Estrutura em chapa de aço reforçada; Structure in reinforced sheet steel;
- Regulação de ar de combustão através de válvula de fácil operação; Combustion air regulation;
- Possibilidade de funcionamento estanque, através da ligação do ar de admissão diretamente do exterior; Possibility of watertight operation through the connection of the intake air directly from the outside;

FUNCIONALIDADES | FUNCTIONALITIES



DADOS TÉCNICOS | TECHNICAL DATA

| | | |
|---|--|--|
|   15 KW |  1,5 - 3,2 Kg/h |  171 m ² |
|  12 KW |  152 mm |  110 Kg |
|  82 % |  230V - 60W |  727 x 599 x 456 mm |

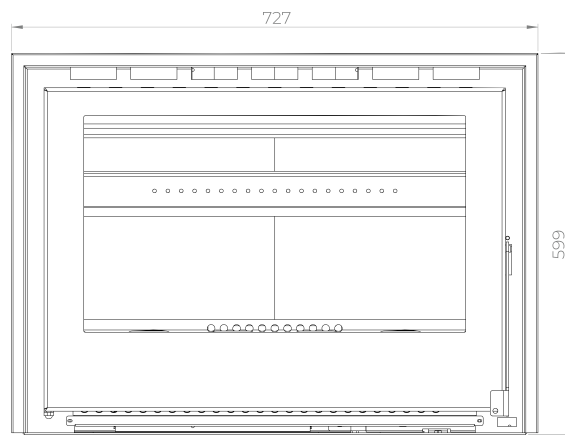

VISTA FRONTAL | FRONT VIEW

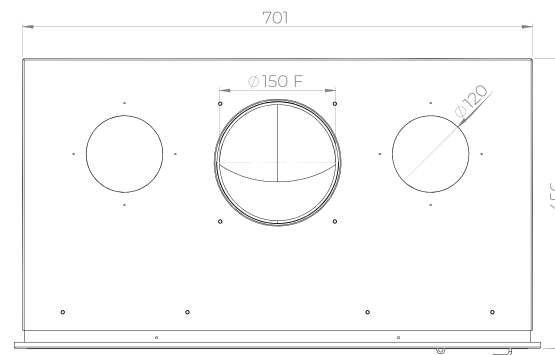



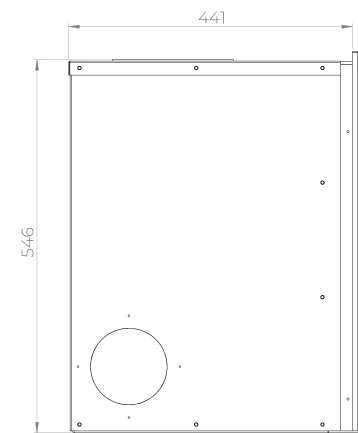







VISTA DE CIMA | TOP VIEW



VISTA LATERAL | SIDE VIEW

DADOS TÉCNICOS | TECHNICAL DATA

| | | |
|---|--|--|
|   15 KW |  1,5 - 3,2 Kg/h |  171 m ² |
|  12 KW |  152 mm |  110 Kg |
|  82 % |  230V - 60W |  727 x 599 x 456 mm |

