

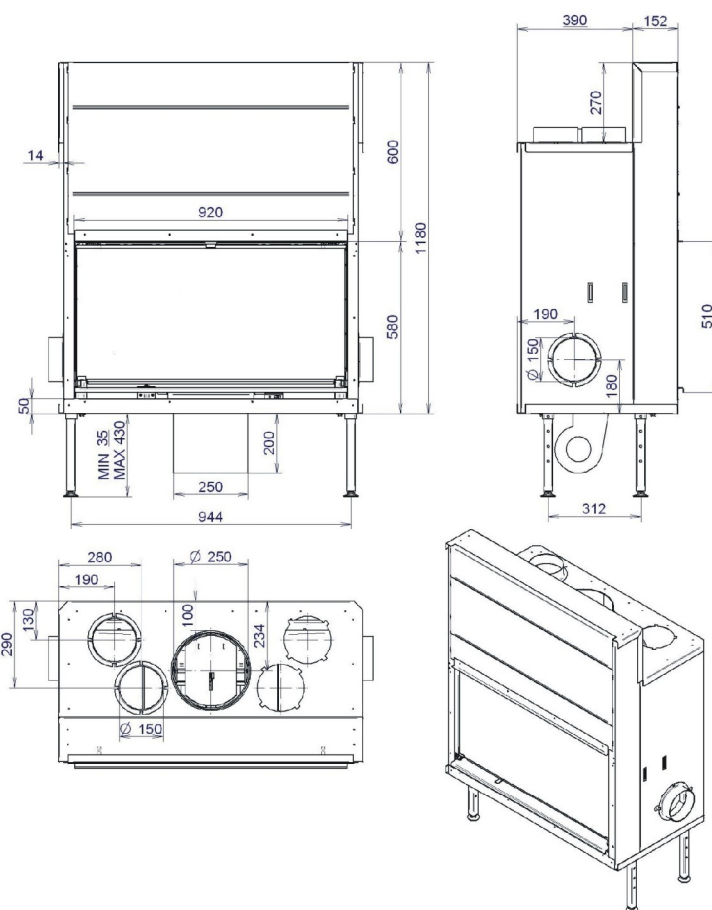

**Splend**<sup>®</sup>  
CONCEPT  
1000H



### Características complementares:

Emissão de CO: 0,08%

Rendimento: 79,5%

Potência calorífica: 14 kW

Temperatura de combustão: 260° C

Peso: 245 kg

Combustível: Lenha

Distância mínima de materiais  
adjacente: 800mm



Porta de Abertura Vertical (guilhotina)



Regulador de Combustão Automático



Cortina de Ar



Alimentação Directa de Ar

**Classificado na classe 1 conforme a Norma EN 13229**

**Certificado e aprovado**