

CRISTAL 78

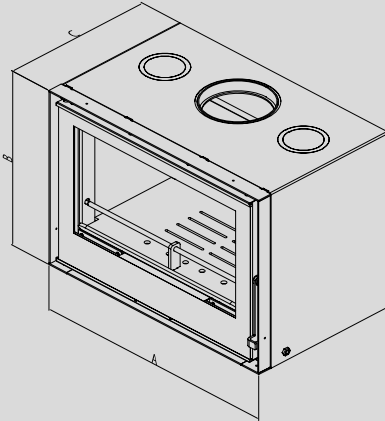

CRISTAL 78

780(a)X548(b)X477(c)

8,4

81

180

A+

2

131