

CRISTAL 98

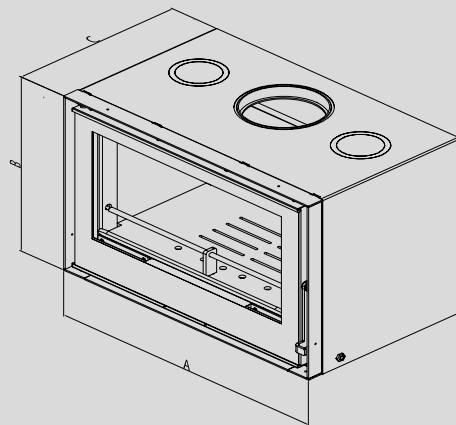

CRISTAL 98



980(a)X552(b)X477(c)



9,4



78



200



A



2,5



161