



Ref. 036ARTEKP

CARACTERÍSTICAS | CHARACTERISTICS

- Saída de Fumos: Superior; Smoke output: Superior;
- Duas saídas de distribuição de calor Ø 120 mm; Two heat exchanger outputs;
- Recuperador de calor com dimensões standard para a maioria das lareiras construídas; With standard dimensions, this appliance fits in most of the fireplaces built;
- Fácil instalação, utilização, acendimento e manutenção; Easy installation, use, ignition and maintenance;
- Câmara de queima com base THERMCORIT<sup>®</sup>; Burning chamber THERMCORIT<sup>®</sup>;
- Laterais e sifão em vermiculite; Sides and siphon in vermiculite;
- Estrutura em chapa de aço reforçada; Structure in reinforced sheet steel;
- Regulação de ar de combustão através de válvula de fácil operação; Combustion air regulation;
- Possibilidade de funcionamento estanque, através da ligação do ar de admissão diretamente do exterior; Possibility of watertight operation through the connection of the intake air directly from the outside;

• Em opção: In option:



- Comando rádio NEO 4 canais; NEO 4 channel radio control;













- Módulo de Internet 4HEAT e app de controlo remoto para android e iOS; Internet module 4HEAT and remote control app for android and iOS;

On/Off (ignição/ extinção); Leitura de temperatura em tempo real; Programação Chrono (diariamente, semanalmente, fim de semana); Acesso total ao menu do teclado; Assistência remota da marca.

On/Off (ignition/extinguish); Temperature reading in real time; Schedule Chrono (daily-weekly-weekend); Full access to the keyboard menu; Remote assistance of the brand.

DADOS TÉCNICOS | TECHNICAL DATA

 10 KW	 0,99 - 1,91 Kg/h	 160 m <sup>2</sup>
 8 KW	 80 mm	 12 Kg
 90 %	 230 V	 138 Kg
		 697 x 603 x 593 mm

FUNCIONALIDADES | FUNCTIONALITIES



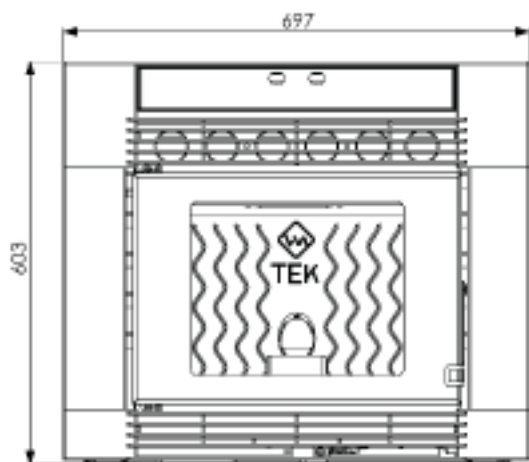

VISTA FRONTAL | FRONT VIEW

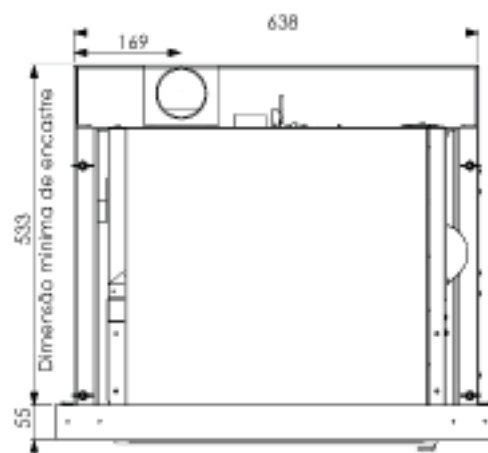



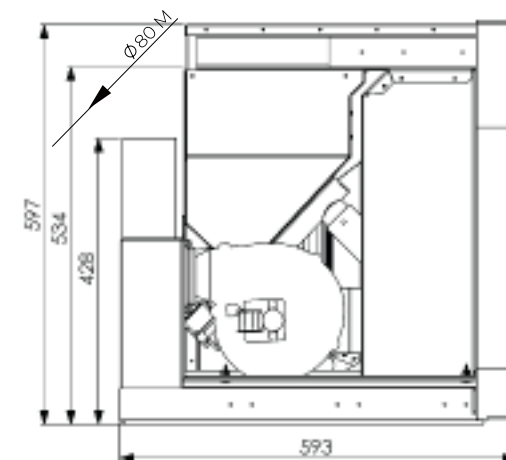







VISTA DE CIMA | TOP VIEW



VISTA LATERAL | SIDE VIEW

DADOS TÉCNICOS | TECHNICAL DATA

    10 KW	 0,99 - 1,91 Kg/h	 160 m <sup>2</sup>
 8 KW	 80 mm	 12 Kg
 90 %	 230 V	 138 Kg
 697 x 603 x 593 mm		